



P-51 STREGA

OPERATING MANUAL



www.rochobby.com

Please visit our homepage for updated product information

WARNING!

 **WARNING:** Read the ENTIRE instruction manual to become familiar with the features of the product before operating. Failure to operate the product correctly can result in damage to the product, personal property and cause serious injury.

This is a sophisticated hobby product and NOT a toy. It must be operated with caution and common sense and requires some basic mechanical ability. Failure to operate this Product in a safe and responsible manner could result in injury or damage to the product or other property. This product is not intended for use by children without direct adult supervision.

This manual contains instructions for safety, operation and maintenance. It is essential to read and follow all the instructions and warnings in this manual prior to assembly, setup, or use, in order to operate correctly and avoid damage or serious injury.

Safety Precautions and Warnings

As the user of this product, you are solely responsible for operating in a manner that does not endanger yourself and others or result in damage to the product or the property of others. This model is controlled by a radio signal subject to interference from many sources outside your control. This interference can cause momentary loss of control so it is advisable to always keep a safe distance in all directions around your model, as this margin will help avoid collisions or injury.

Age Recommendation: Not for children under 14 years. This is not a toy.

- Never operate your model with low transmitter batteries.
- Always operate your model in an open area away from cars, traffic or people.
- Avoid operating your model in the street where injury or damage can occur.
- Never operate the model in the street or in populated areas for any reason.
- Carefully follow the directions and warnings for this and any optional support equipment (chargers, rechargeable battery packs, etc.) you use.
- Keep all chemicals, small parts and anything electrical out of the reach of children.
- Moisture causes damage to electronics. Avoid water exposure to all equipment not specifically designed and protected for this purpose.
- Never lick or place any portion of your model in your mouth as it could cause serious injury or even death.

Notice: The model of **P-51** racer is specially designed for the common cruising speed and the blast scale speed racing, please refer to the manual for the common speed version installation and refer to the **Appendix** for the alternative racer version installation

ROCHOBBY Friendly Reminder



Thank you for purchasing a RocHobby product. Our goal is to provide high quality products and offer great customer service. If you have any problems with your product or want to offer suggestions for improvements (such as plane design, packaging, building instructions, etc.) please feel free to contact us at info@fmsmodel.com

Table of contents

Kit contents	1
The spare parts list.....	1
Spare parts list content	
The illustration of the spare parts	
Charging the Flight Battery	3
Low Voltage Cutoff	3
Fuselage/tail assembly	4
Install the control horn	
Electronics installation and set-up	6
Install the Horizontal stabilizer	
Bind the receiver to the transmitter	
Install the receiver	
Install the battery	
Hook on the linkage rod of the stabilizer	
Test the stabilizer control servos	
Main wing assembly, set-up and installation	9
Install the control rod	
Test the retract	
Install the wing fairing	
Mount the main wing	
Final assembly and set-up procedures	12
Important ESC and model information	
The transmitter and model set up	
Check the control throws	
Install the propeller set	
Install the accessories	
Check the C.G. (Center of Gravity)	
Before flying the model	20
Find a suitable flying site	
Perform the range check of your plane	
Monitor your flight time	
Flying your model	21
Take off	
Flying	
Landing	
Maintenance	
Troubleshooting	22
A M A	24

Kit contents



Kit contents

1. The fuselage assembly (With the motor, the canopy, the electronic parts, ESC)
2. Main wing (With all electric device installed)
3. Horizontal stabilizer with elevator joiner installed
4. Vortex generator set (2 PCS)
5. Propeller, spinner set
6. Spare parts bag
7. Wing fairing

The spare parts list

Replacement parts for the **P51 strega** are available using the order numbers in the Spare parts list that follows. The fastest, most economical service can be provided by your RocHobby on-line dealer. Please visit <http://www.rochobby.com/buy> for a list of dealers

Spare parts list content

Spare parts list content

- KA101 Fuselage (With all the plastic parts and rudder installed)
- KA102 Main wing (With the control horn installed)
- KA103 Horizontal stabilizer (With the elevator joiner installed)
- KA104 Wing fairing set
- KA105 Cockpit (With the pre installed pilot and the canopy)
- KA106 Cowl
- KA107 Spinner

- KA108 Propeller (10.5*8 4 blades scale propeller)
 - KA109 Vortex generator (2 pcs)
 - KA110 Air speed head
 - KA111 Cross motor mount (Multi-function mount for two configurations)
 - KA112 Main landing gear struts
 - KA113 Main landing gear system (E-retract with strut and tires)
 - KA114 Motor shaft(3536)
 - KA115 Motor shaft(3648)
 - KA116 linkage rod (With the clevis and the rubber rings)
 - KA117 Decal sheet
 - KA118 Motor (3536-KV750 Brushless)
 - KA119 Motor (3648-KV770 Brushless)
 - KA120 ESC (35A with SBEC)
 - KA121 ESC (70A with SBEC)
 - KA122 E-retact
 - KA123 Servo (9g Normal)
 - KA 124 Servo (9g digial metal gear servo)
 - KA 125 Motor board
- Note:** All of the parts are painted with no decal applied.

The illustration of the spare parts



KA 101



KA 102



KA 103



KA 104



KA 105



KA 106



KA 107



KA 108



KA 109



KA 110



KA 111



KA 112



KA 113



KA 114



KA 115



KA 116

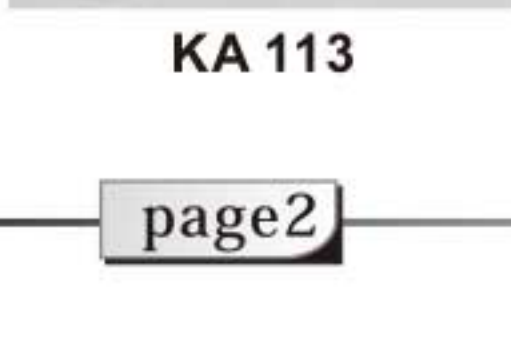

KA 117



KA 118



KA 119



KA 120



KA 121



KA 122



KA 123



KA 124



KA 125

Charging the Flight Battery

The Battery Charger is designed to safely charge the Li-Po battery,

Caution: All instructions and warnings must be followed exactly. Mishandling of Li-Po batteries can result in fire, personal injury, or property damage.

Battery warning:

By handling, charging or using the included Li-Po battery you assume all risks associated with lithium batteries.

If at any time the batteries begin to swell, or balloon, discontinue use immediately!

Charging or discharging a swelling or ballooning battery can result in fire.

Always store the batteries at room temperature in a dry area to extend the life of the battery. Always transport or temporarily store the battery in a temperature range of 40-120°F. Do not store battery or model in a car or in direct sunlight. If stored in a hot car, the battery can be damaged or even catch fire.

Never use a Ni-Mh charger. Failure to charge the battery with a compatible charger may cause fire resulting in personal injury and property damage.

Never discharge Li-Po cells to below 3V.

Never leave charging batteries unattended.

Never charge damaged batteries.

Charging the flight battery

When charging the battery, make certain the battery is on a heat-resistant surface, charge the battery before assembly of the airplane. Install the fully charged battery to perform control tests and binding.

Low voltage cut off (LVC)

When a Li-Po is discharged below 3V per cell, it will not hold a charge. The ESC protects the flight battery from over-discharge using Low Voltage Cutoff. Before the battery charge decreases too much, LVC removes power from motor in two ways: (1) Reduces power - ESC reduces motor power (recommended), (2) Hard cutoff - ESC instantly cuts motor power when the pre-set Low Voltage Protection Threshold value is reached. These settings can be changed using the ESC programming guide.

Fuselage/tail assembly

Install the Control horn

1. Attached the control horn to the left side of the rudder with horn facing toward the hinge line.

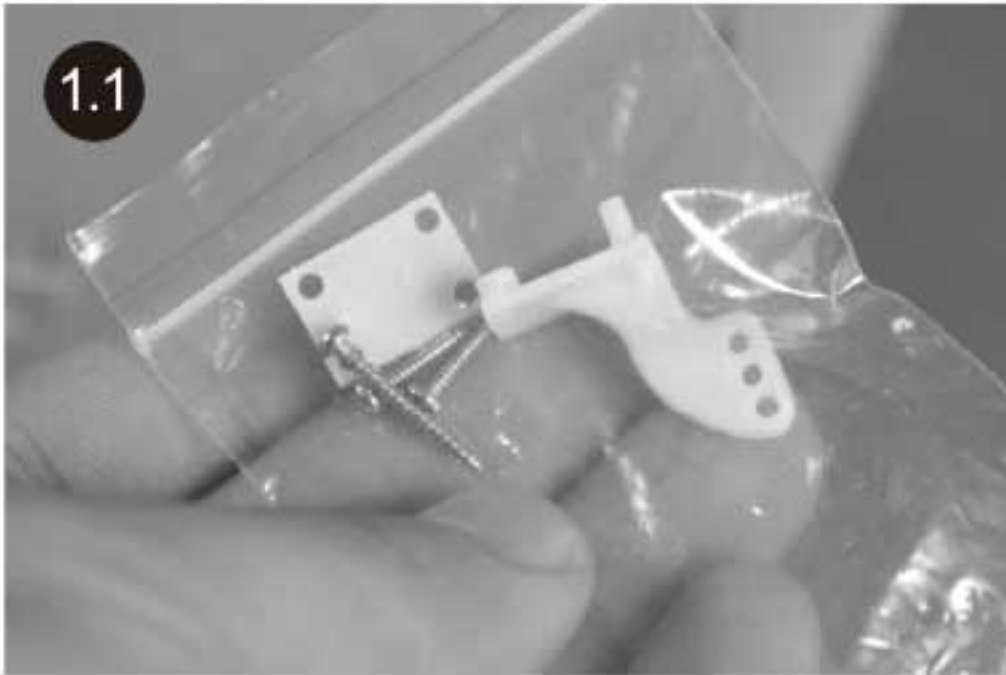

2. Secure the horn by placing the screws through the backplate first then into the control horns.
Note: Use the longer screws for the thicker foam areas (leading edge) of all control surfaces.



3. Check to make sure the screws are firmly inserted into the control horns.

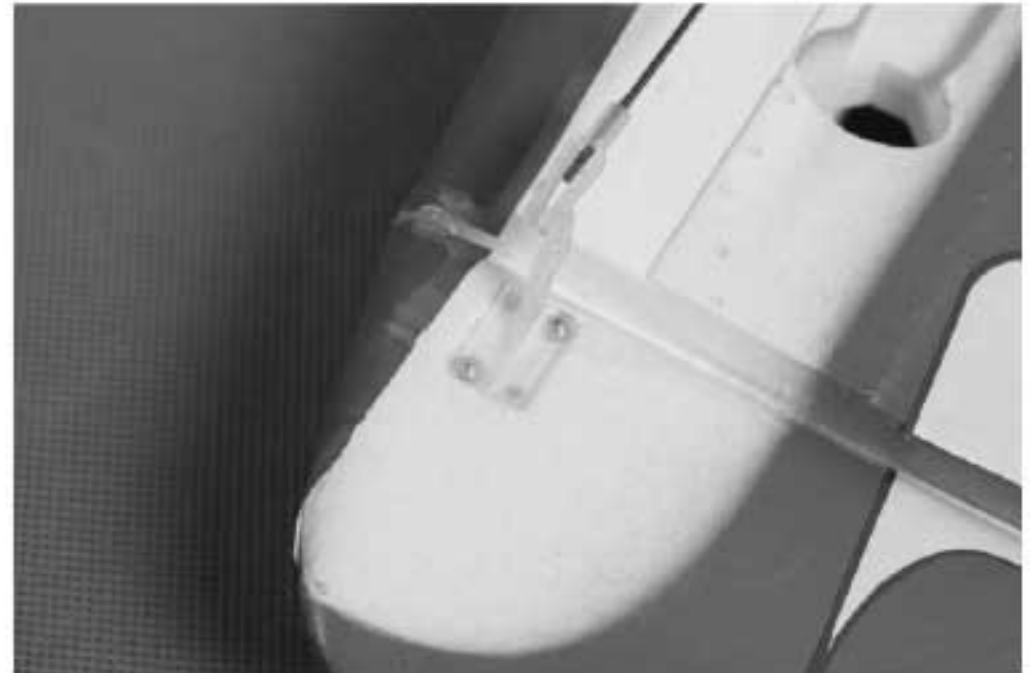

4. Install the aileron control horns on the servo side of the main wing with the horn towards the hinge line as the picture shows.

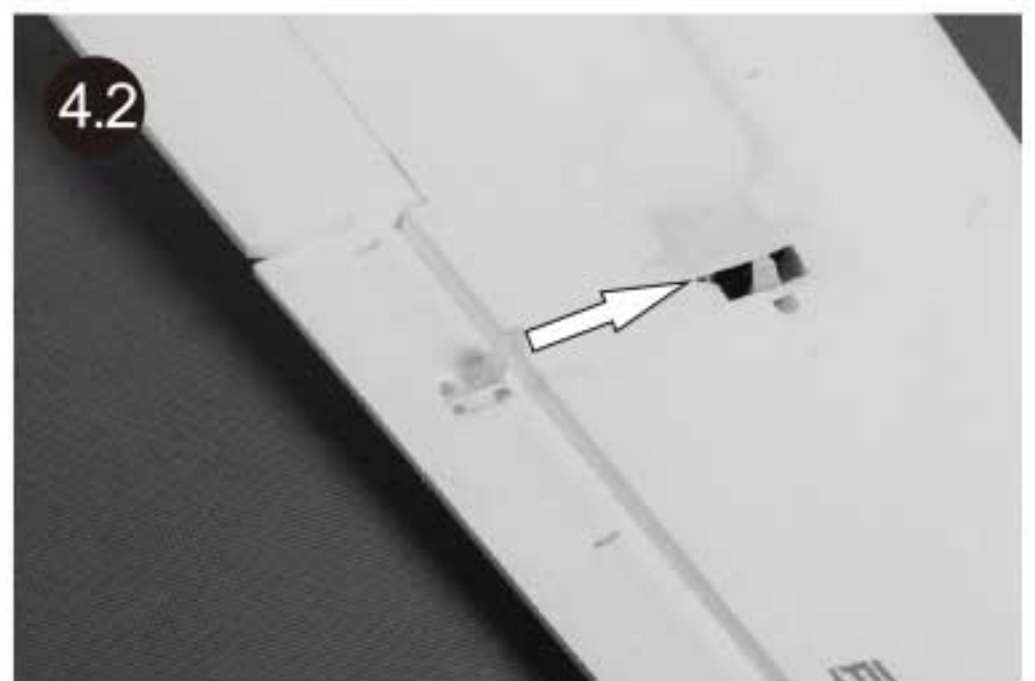

Fuselage/tail assembly

Install the Control horn

5. Attach the flap control horn on the servo side of the main wing with the horn towards the hinge line as shown (5.2).



Install the Horizontal stabilizer

1. Insert the left stabilizer fully into place with the mounting nuts down. Make sure to insert the round bar into the glass fiber socket and the rectangular plastic bar (with the eyelet) into the rectangular socket on the stabilizer.



2. Insert the fiberglass tube into the tail hole as picture shows. Then Insert the right stabilizer half into the tail mounting slot using the same method as the left half. Note: Make sure the elevator connector interlocks with each other before you fully connect both halves.

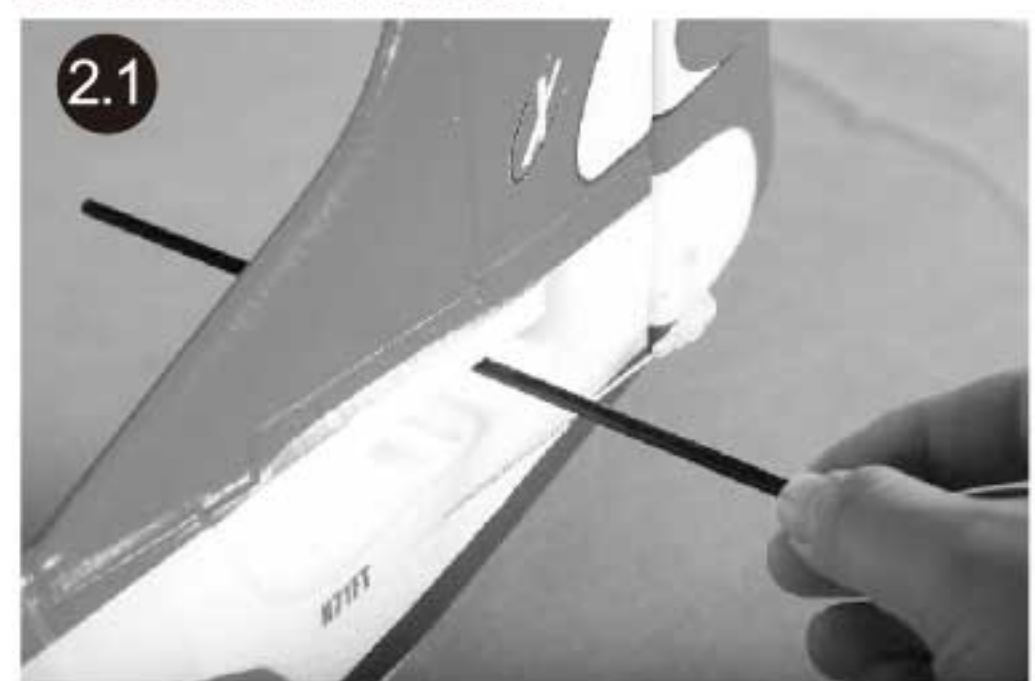

Fuselage/tail assembly

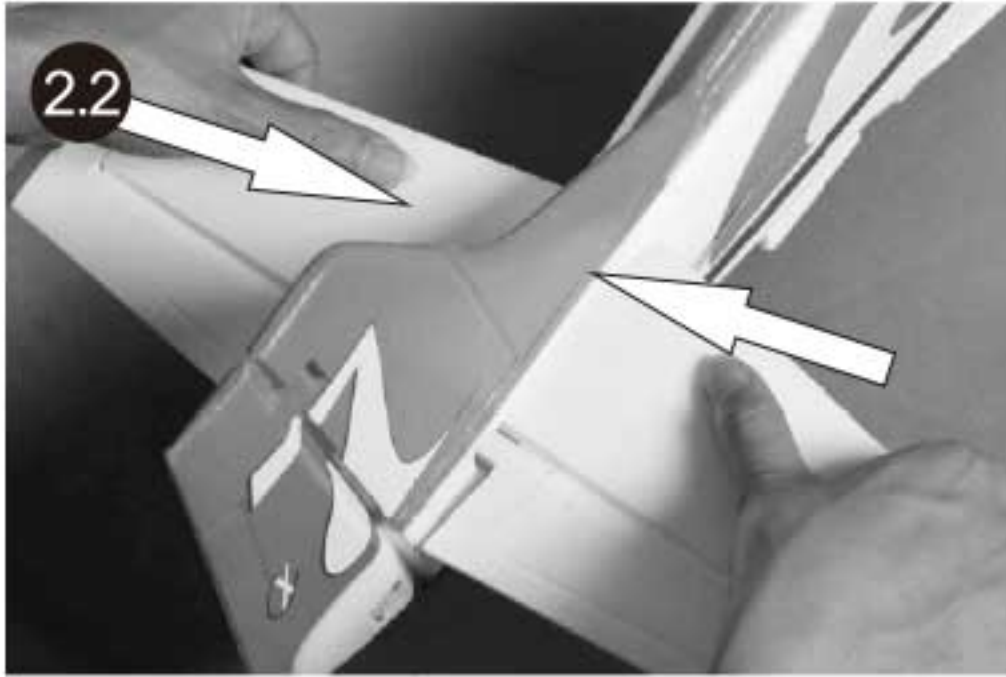

3. Turn over the plane so the bottom of the plane faces up. Secure the stabilizer using the provided screws.
(Screws: PA2.6*10 2PCS)



4. Secure the elevator connector halves together from bottom side of the elevator using the provided self tapping screw.
(Screw: PA2.0*8)

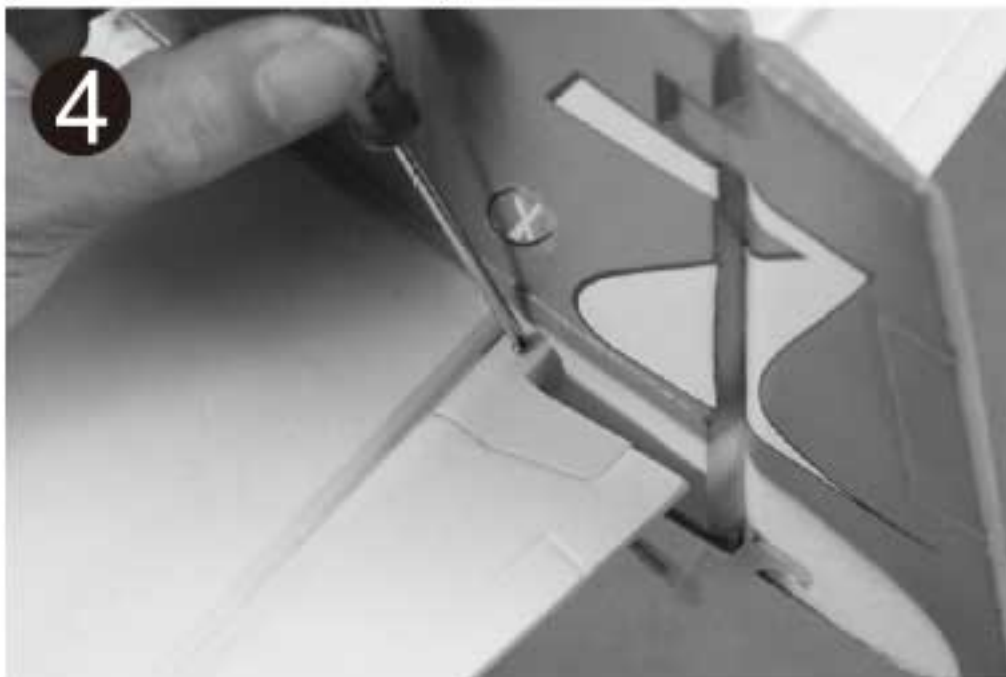

Electronics installation and set-up

Bind the receiver to the transmitter

1. Before getting started, bind your receiver with your transmitter. Please refer to your **Transmitter Manual** for proper operation. **CAUTION:** To prevent personal injury, **DO NOT** install the propeller assembly onto the motor shaft while binding the receiver or while doing ANY test steps in this manual .

Install the receiver

1. Remove the battery hatch cover by lifting the band on the rear end of the cover. The cover is attached in place by four magnets, two in the rear and two on the foam nose in front.



2. Disconnect the battery from the ESC after the binding process is complete. Turn off the transmitter and remove the bind plug as necessary. Plug the elevator and the rudder servos into the receiver.

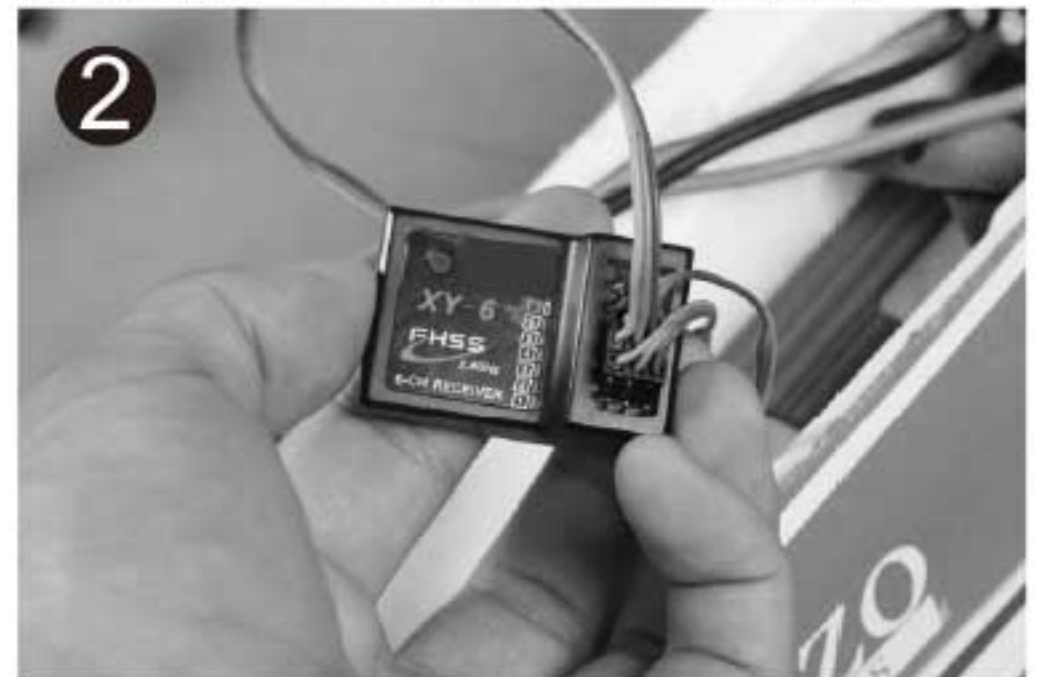

Electronics installation and set-up

3. Receiver connection diagram.

Note: All servo and retract leads have been specifically labeled for your convenience. Use the provided Y-harness for situations where two or three servos are controlled by one channel; for example ailerons, landing gear, and flaps. Refer to the diagram below for recommended connections.

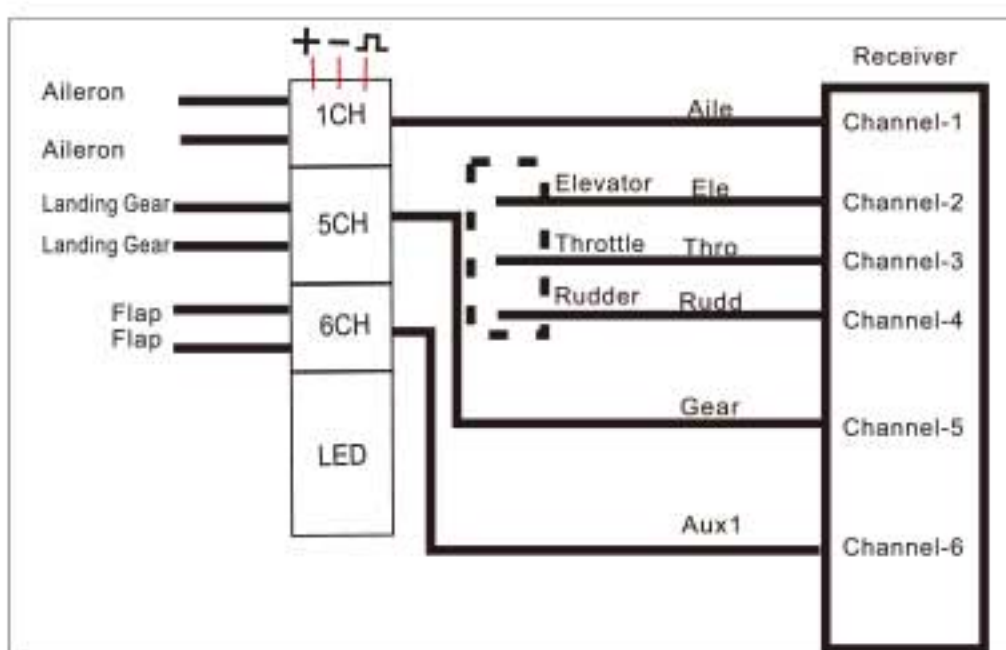

4. Install the receiver in the area shown and secure using double sided tape or velcro.

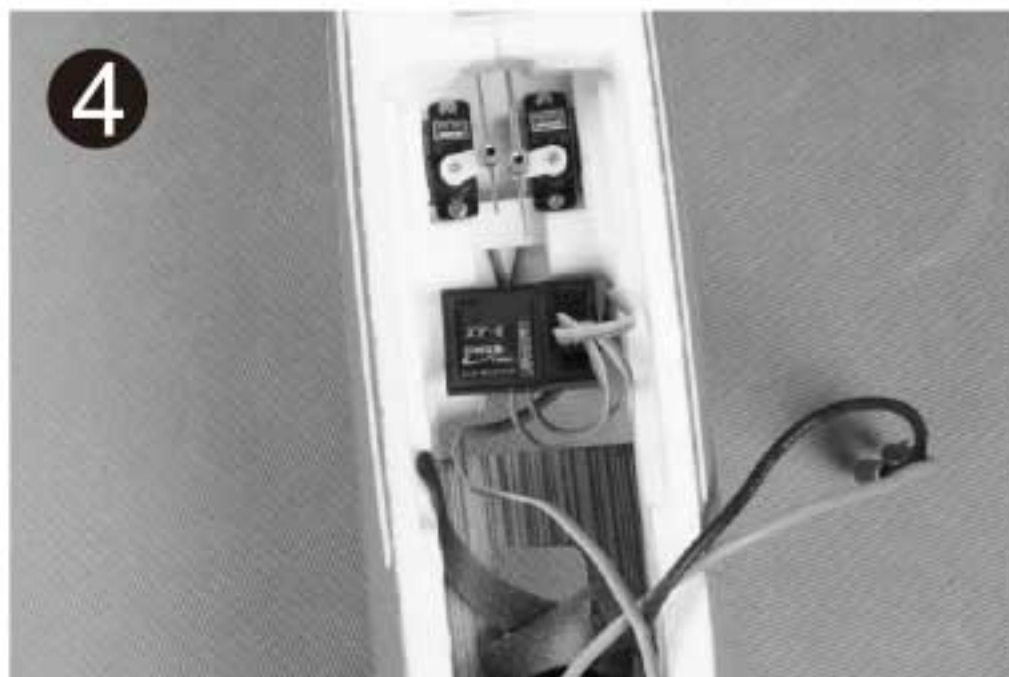

Install the Battery

- Slide the battery into the battery hatch with the power supply cable toward the rear end of the plane and secure it using the pre-installed hook and loop tape. **Note:** You may need to relocate the battery position to achieve the correct CG for your model.

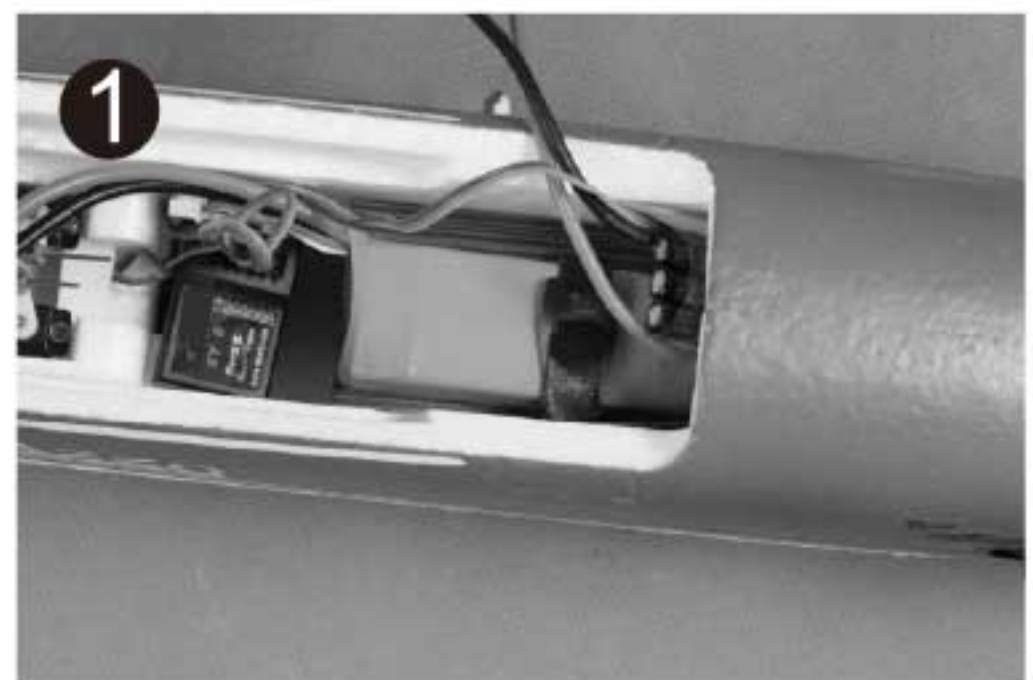

Hook on the linkage rod of the stabilizer

- Loosen the screws on the control connectors which hold the control rods in place.

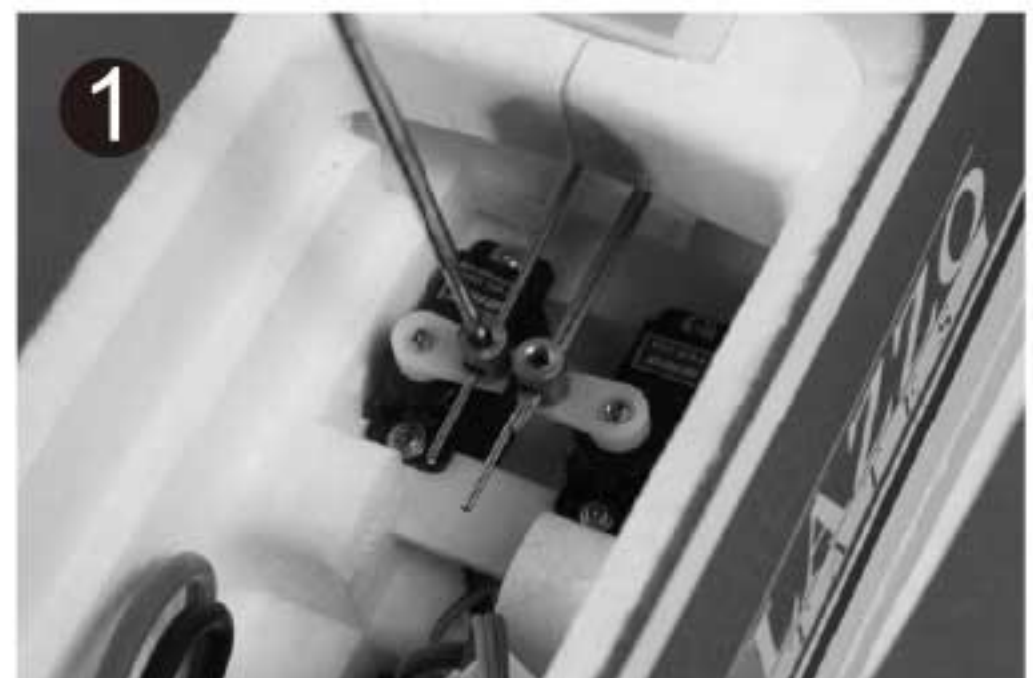

Electronics installation and set-up

2. Snap the clevis into the elevator surface control horn.



3. The provided piece of fuel tubing keeps the clevis closed during flight. Secure all linkages using this same method.

Note: Do not slide the tube too close to the control horn as it may impede the movement of the control surface.



4. Repeat the steps 2 & 3 for the all other linkage hook-ups.

Test the stabilizer control servos

1. Make sure all the control sticks on your radio are in the neutral position (rudder, elevator, ailerons) and the throttle is in the OFF position. Turn on the transmitter and power on the model. Move the elevator and the rudder on the transmitter to make sure the aircraft control surfaces move correctly. If the controls respond in the opposite direction, reverse the servo direction using the settings on your transmitter.

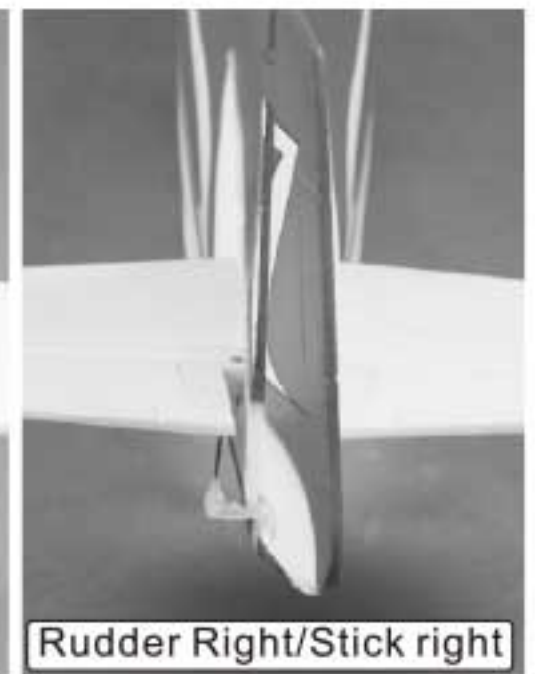
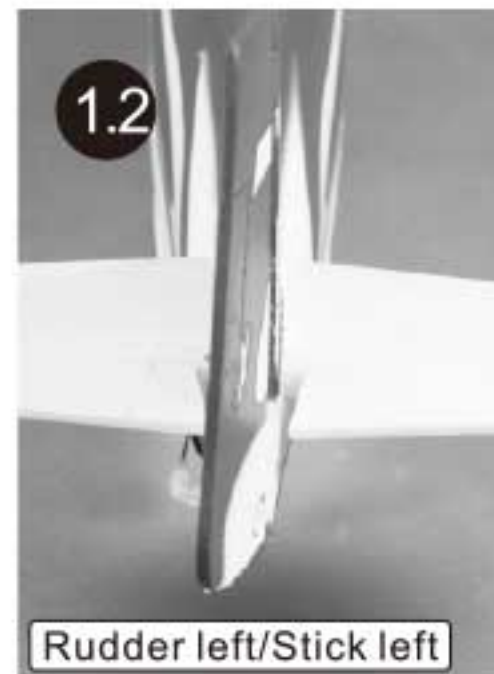

2. Make sure all the control surface trim in the neutral position. For computerized transmitters, use the servo/channel sub-trim to trim each control surface.

Note: Make sure the trim and the sub-trim are in the neutral position before making mechanical adjustments to the linkages. Adjust the servo arms mechanically or via your radio's trim feature so that each servo is in the neutral or centered position.

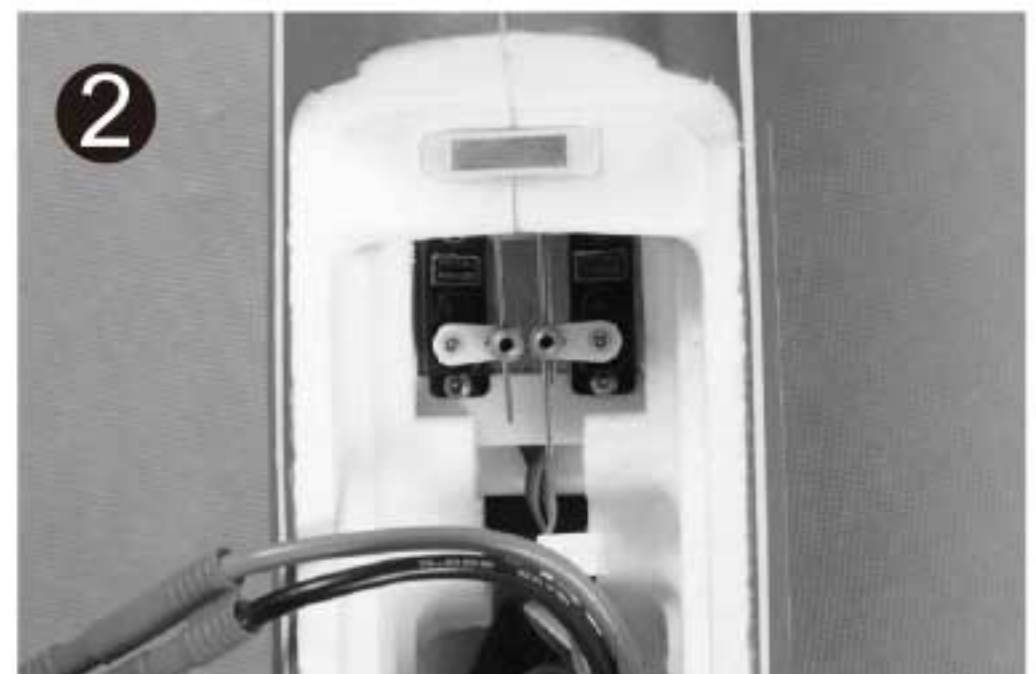

Main wing assembly, set-up and installation

- Adjust the linkage on the control connector to make sure the leading edge of the elevator and the rudder are even with the leading edge of the horizontal stabilizer and the vertical stabilizer respectively.

Note: Use a drop of thread lock on the control connector screw before securing the rod in place.

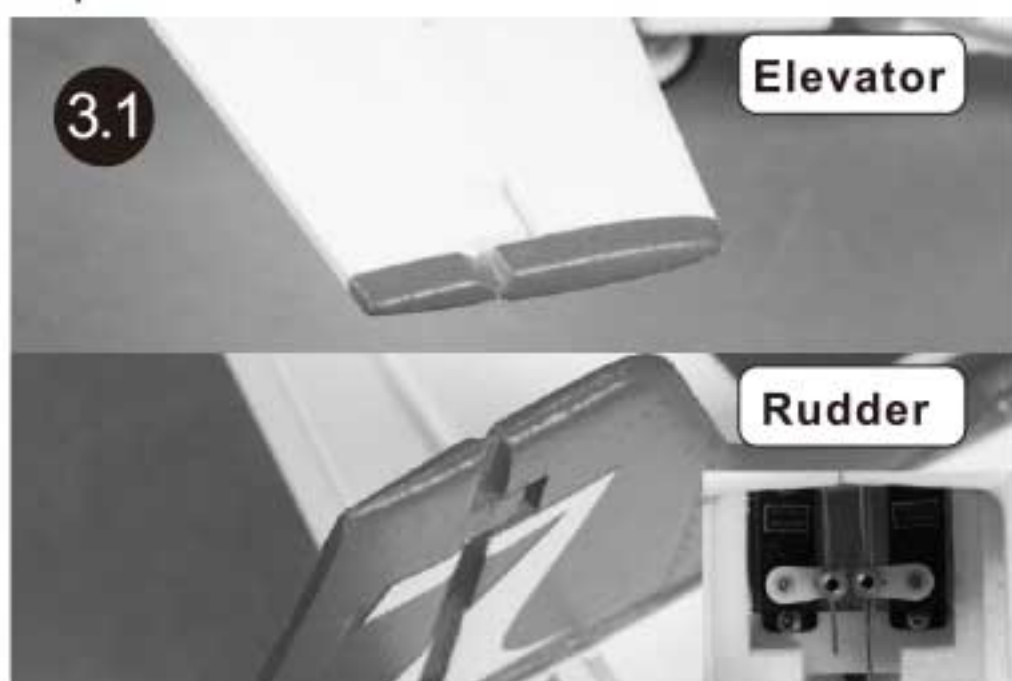

- Adjust the control connector on the rear landing gear steering arm to make sure the wheel aligns with the centerline of the fuselage.

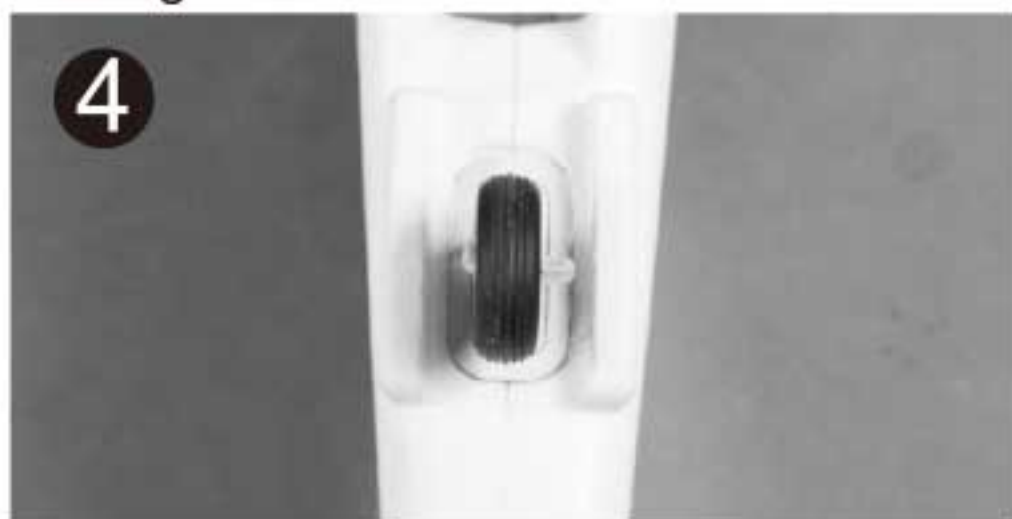

- The motor should rotate counterclockwise when viewing the plane from the front. If the motor moves in the opposite direction, switch any two wires between the motor and the ESC.



Install the control rod

- The standard hole settings for linkage connections are shown by the black arrows in the diagram below. You can increase or decrease the movement of your control surfaces by changing the hole location of your servos. The diagram below provides further details.

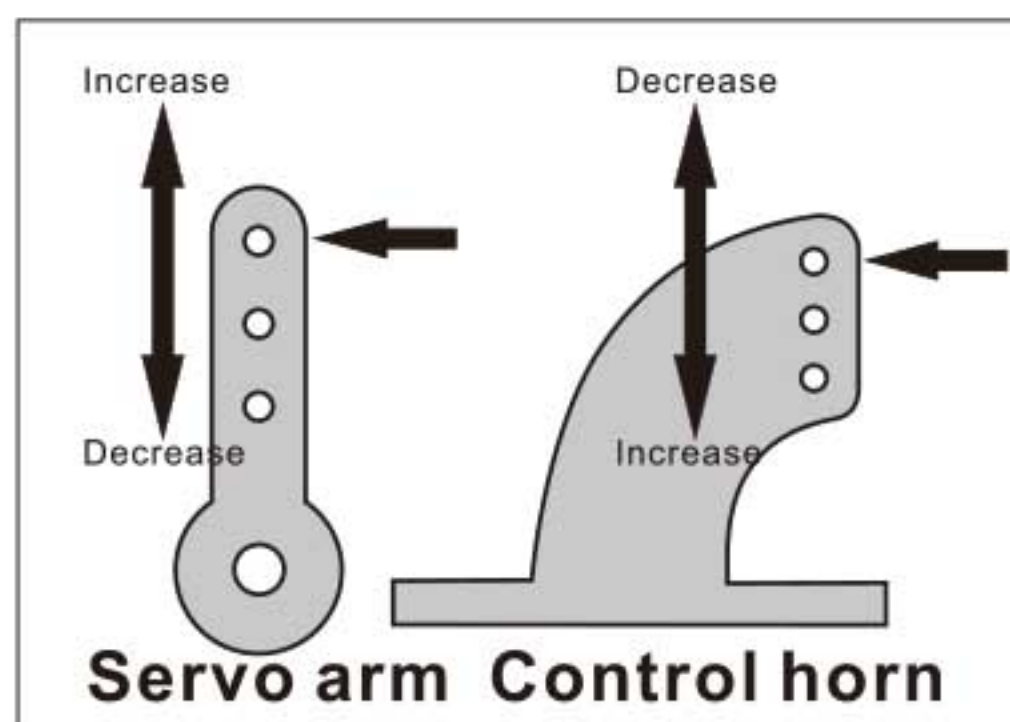

- Make sure the aileron servo horns are perpendicular with the wings when your transmitter's aileron control stick is in the neutral position. Put the Z-bend end of the linkage into the desired servo control horn hole of the main-wing. It is a tight fit and should allow the linkage to move just slightly within the hole to avoid binding up. Hook on the clevis in the same method used with the horizontal and vertical stabilizers.

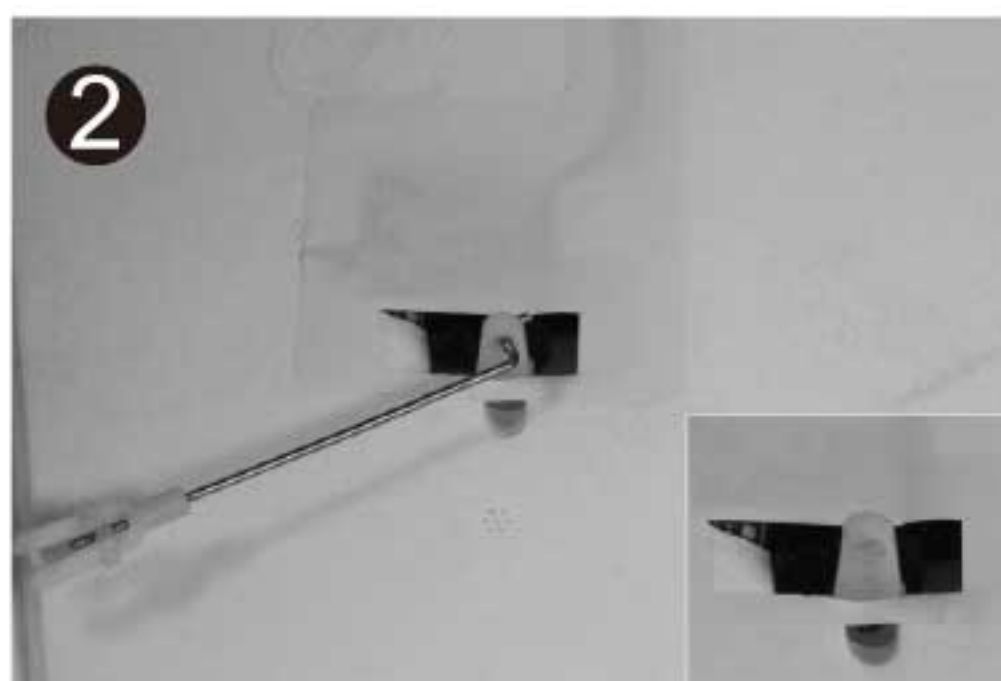

Main wing assembly, set-up and installation

3. Connect both flap servos to your receiver. Toggle the flaps switch on your radio to put the flaps in the up position (figure 3.2).

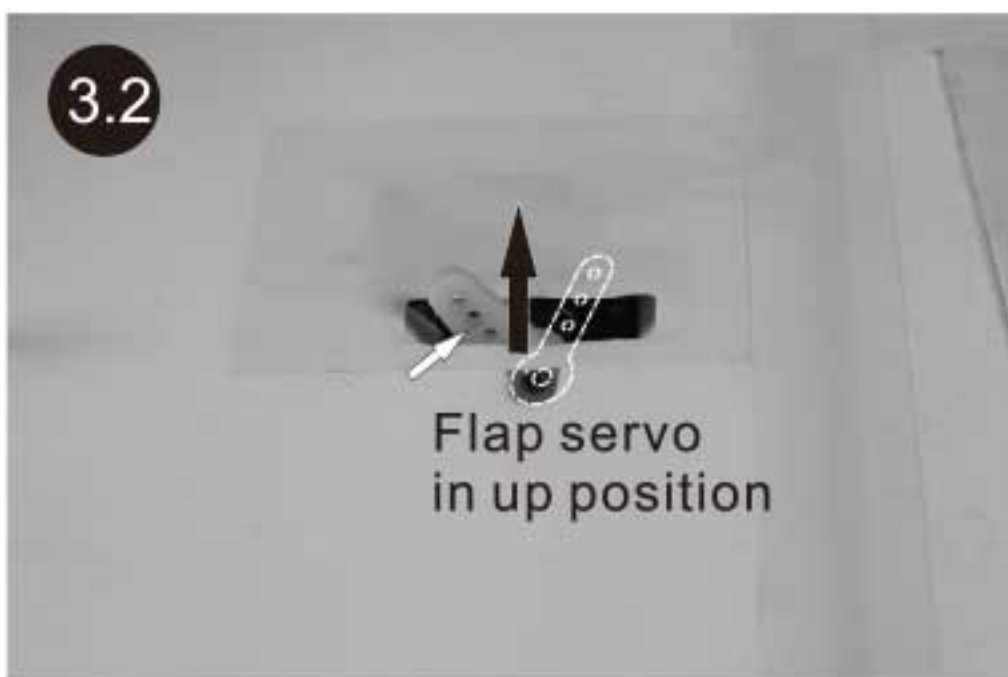
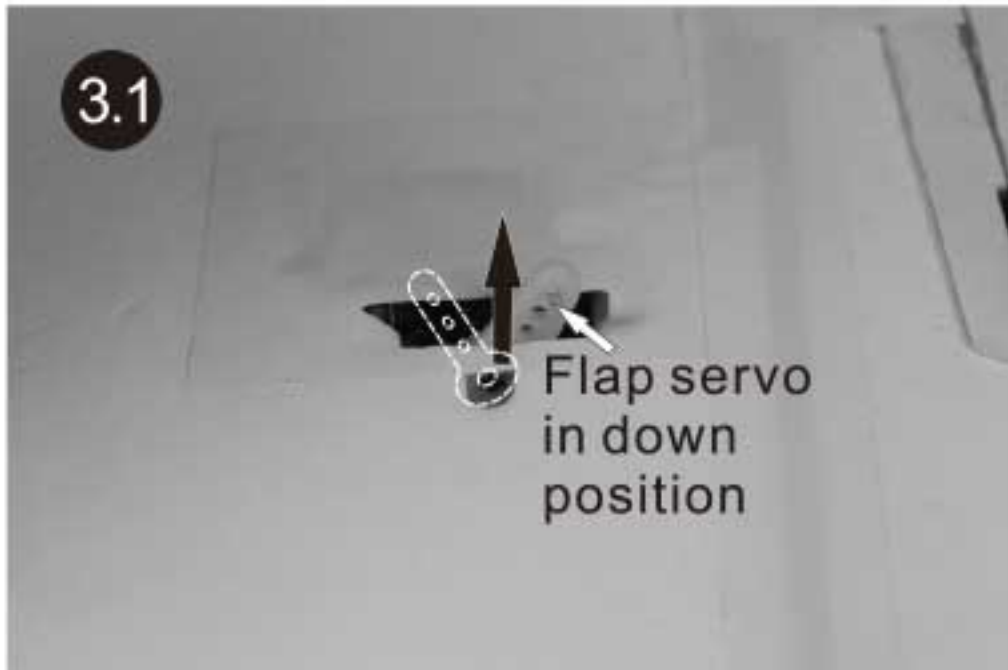

4. Insert the z-bend end of the flap linkage into the servo horn. Connect the clevis to the flap control horn. The clevis should be rotated clockwise or counter clockwise so that the flap is centered with the edge of the wing.

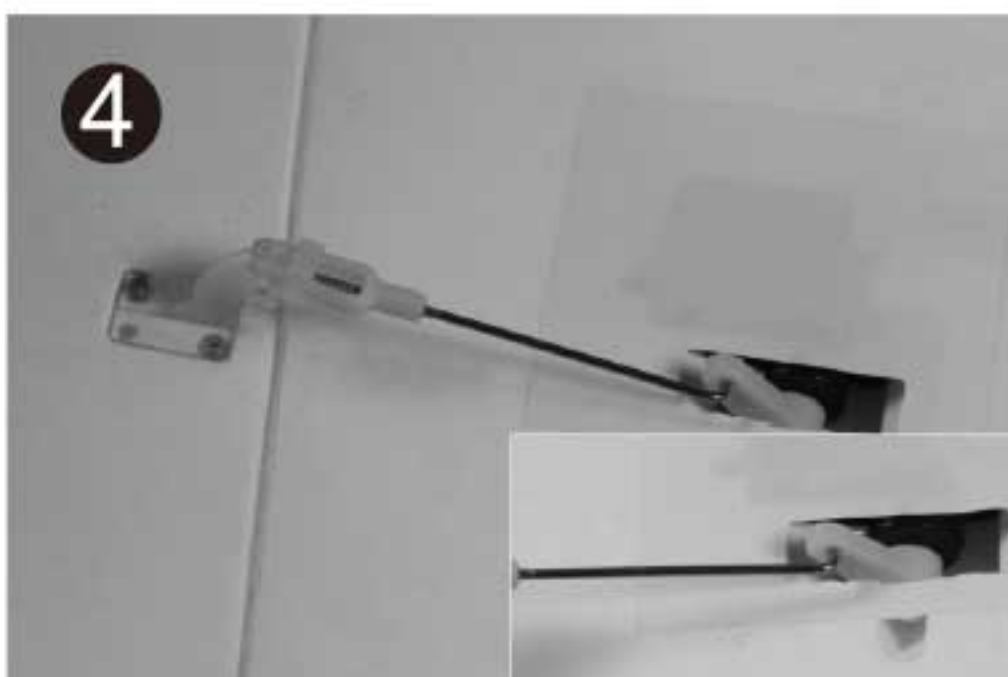

Test the retract

1. Connect electronic retracts to your receiver. Cycle the retractable main landing gears several times to ensure proper function.

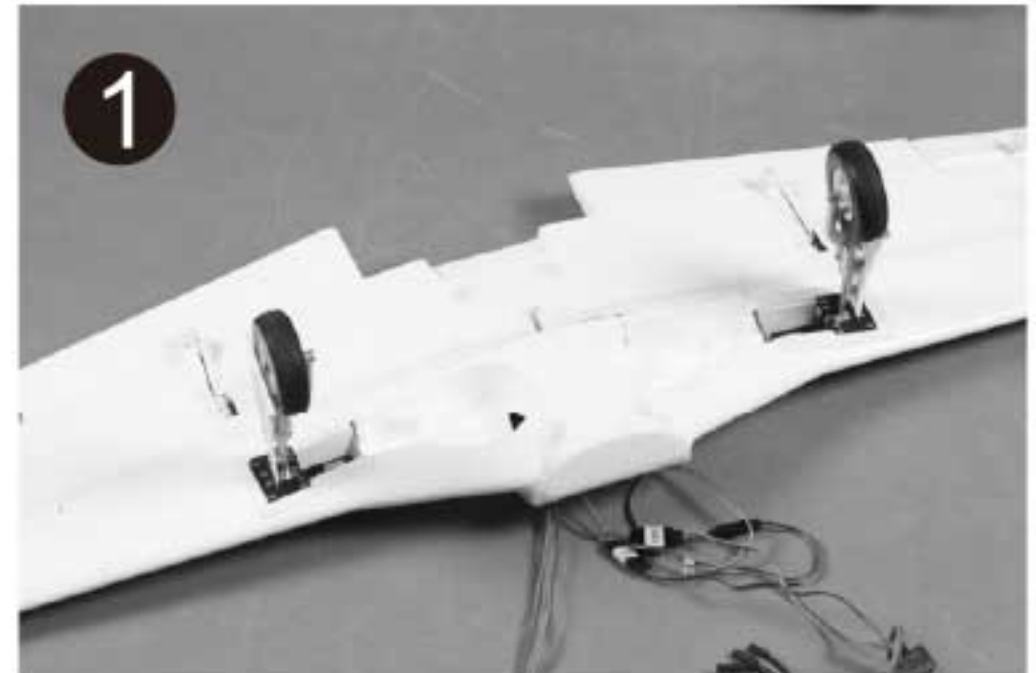

Install the wing fairing

1. Dry fit the main wing fairing roots to ensure proper orientation before gluing.

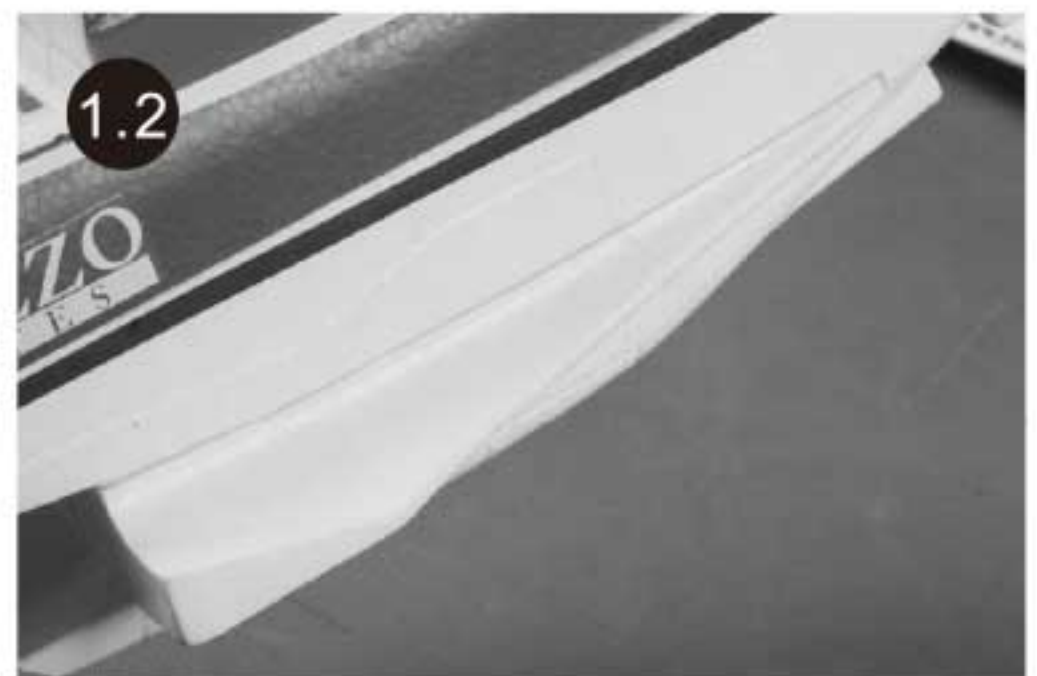
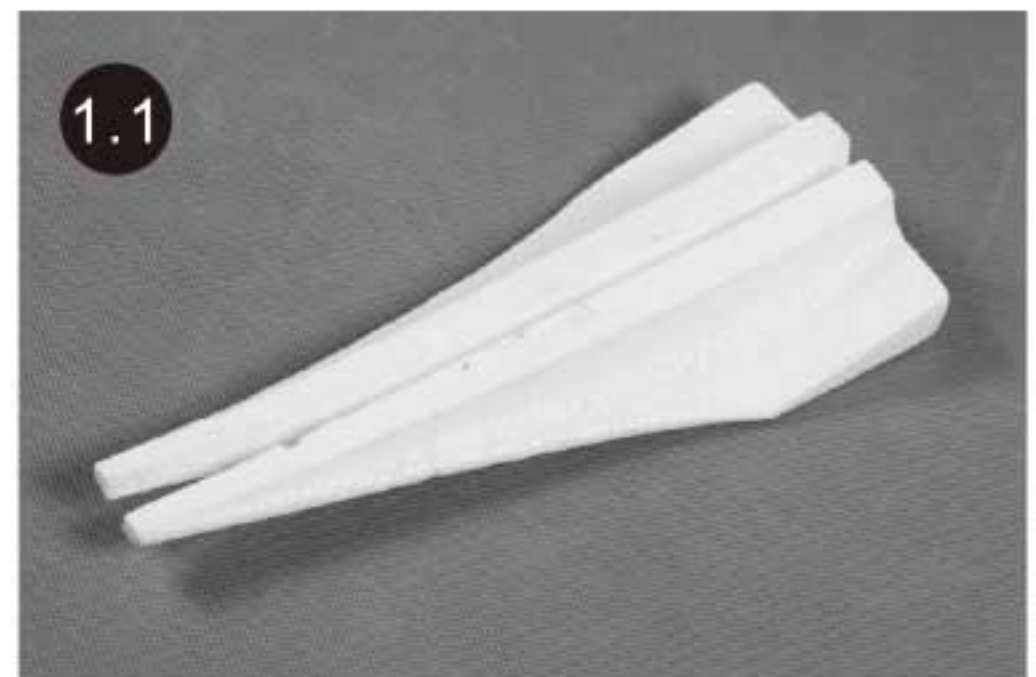

Main wing assembly, set-up and installation

2. Glue each fairing back into place.

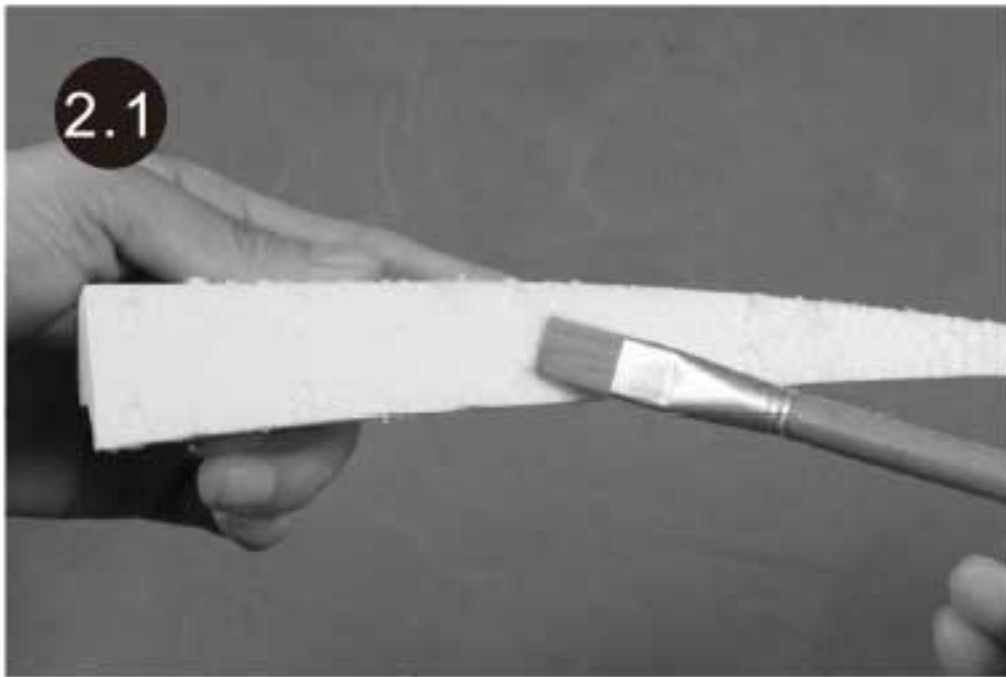

Mount the main wing

1. Seat the wing to the wing bay by threading the servo leads through the hole on the bottom of the fuselage and into the receiver hatch area.

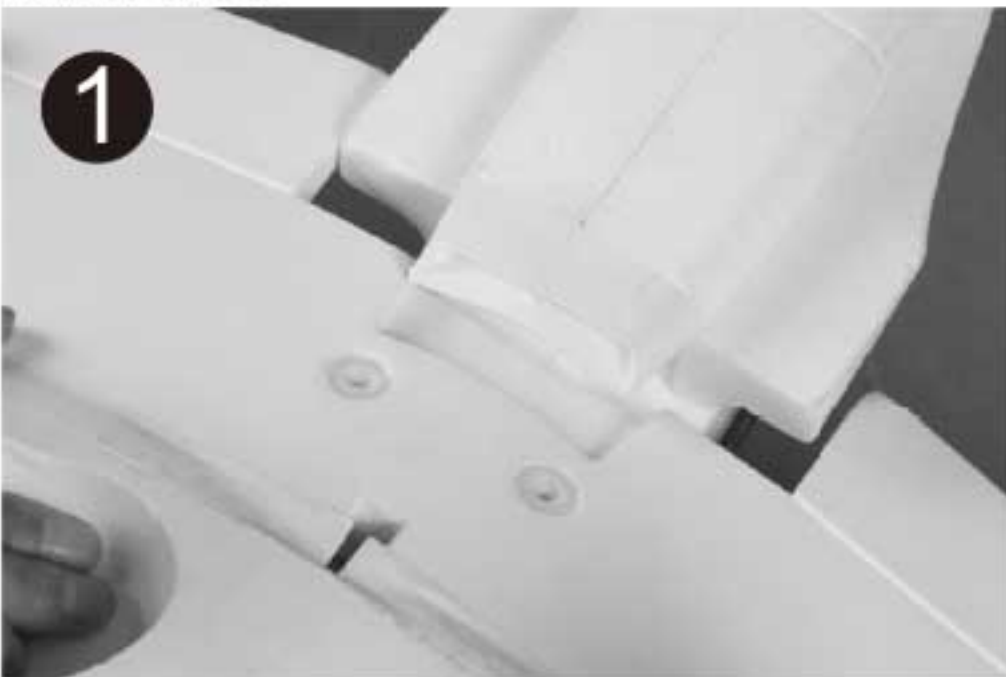

2. Gently pull the servo wire from the receiver hatch area before fully seating the main wing into place. This will ensure the servo leads do not get pinched between the main wing and fuselage.



3. Check to make sure the main wing fully seats into place before securing it. Secure the wing to the fuselage using the screws PM 3*20 and make sure it is tight enough.

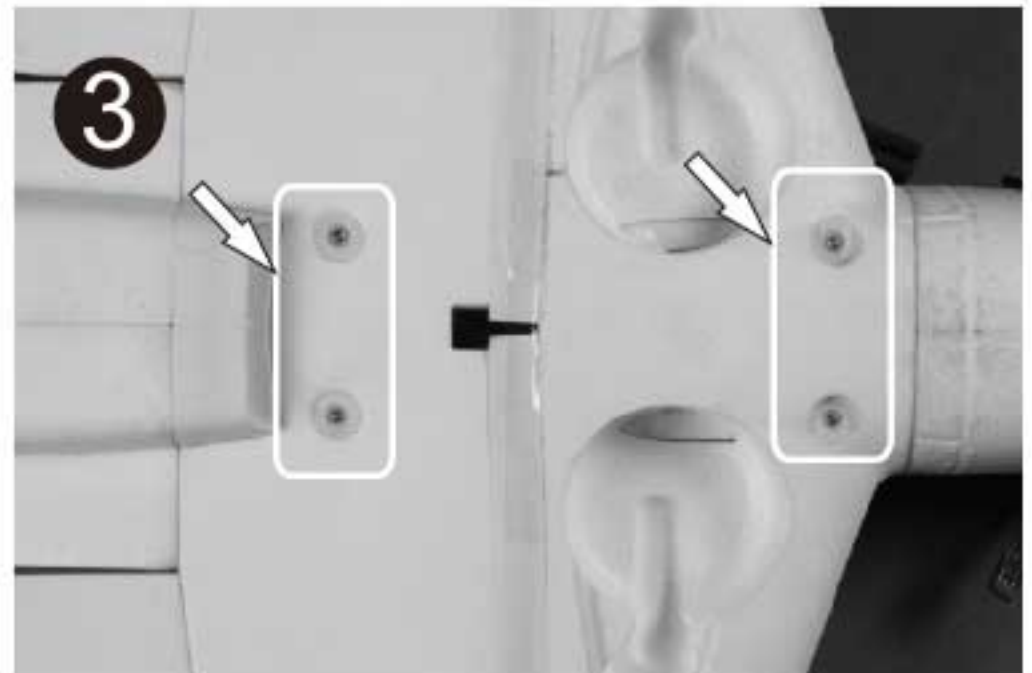

Final assembly and set-up procedures

Important ESC and model information

1. The ESC included with the **Strega** has a safe start. If the motor battery is connected to the ESC and the throttle stick is not in the low throttle or off position, the motor will not start until the throttle stick is moved to the low throttle or off position. Once the throttle stick is moved to the low throttle or off position, the motor will emit a series of beeps. Several beeps with the same tune means the ESC has detected the cells of the battery. The count of the beeps equal the cells of the battery. The motor is now armed and will start when the throttle is moved.
2. The motor and ESC come pre-connected and the motor rotation should be correct. If for any reason the motor is rotating in the wrong direction, simply reverse two of the three motor wires to change the direction of rotation.
3. The motor has an optional brake setting. The ESC comes with the brake switched off and we recommended that the **Strega** be flown with the brake off. However, the brake could be accidentally switched on if the motor battery is connected to the ESC while the throttle stick is set at full throttle. To switch the brake off, move the throttle stick to full throttle and plug in the motor battery. The motor will beep one time. Move the throttle stick to low throttle or the off position. The motor is ready to run and the brake will be switched off.
4. Battery Selection and Installation. We recommend the 11.1V 1800mAh 25C(**180g/6.3oz**) Li-Po battery for the normal speed version Strega. If using another battery, the battery must be at least a 11.1V 1800mAh 25C battery. Your battery should be approximately the same capacity, dimension and weight as the 11.1V 1800mAh 25C Li-Po battery to fit in the fuselage without changing the center of gravity significantly. (Low speed version)
5. The specification of the model is as follows:

The normal speed version

Wing span: 1070mm/42.2in
Length: 970mm/38.6in
Motor : 3536-KV750
ESC : 35A with integrated BEC
Battery : 11.1V 1800mAh 25C
Servo : 9g*4
Approx flying weight: 920g
Propeller: 10.5*8 four blades scale propeller
Wing area: 21.0dm²
Wing loading: 43.8 g/dm²

The speed racing version

Wing span: 1070mm/42.2in
Length: 970mm/38.6in
Motor : 3648-KV770
ESC : 70A with integrated BEC
Battery : 14.8V 2200mAh 25C
Servo : 9g*6
Approx flying weight: 1270g
Propeller: 10.5*8 four blades scale propeller
Wing area: 21.0dm²
Wing loading: 60.0 g/dm²

Final assembly and set-up procedures

The transmitter and model set up

Before getting started, rebind your receiver with your transmitter if necessary.

CAUTION: To prevent personal injury, DO NOT install the propeller assembly onto the motor shaft while testing the control surfaces .

Tips: Make sure all control sticks on your radio are in the neutral position (rudder, elevator, ailerons) and the throttle in the OFF position. Make sure both ailerons move up and down (travel) the same amount. This model tracks well when the left and right ailerons travel the same amount in response to the control stick.

1. Move the controls on the transmitter to make sure aircraft control surface move correctly. See diagrams below. If controls respond in the opposite direction, reverse the direction of the flight controls. Refer to your transmitter's instructions for changing direction of transmitter flight controls.

	Bank Left		Aileron
	Bank Right		
	Climb		Elevator
	Descend		
	Yaw Left		Rudder/ Steering
	Yaw Right		

Final assembly and set-up procedures

2. Recheck to align the control surfaces by using the trim feature on your transmitter. The ailerons align with the trailing edge of the wing tip. The flaps level with the wing root.

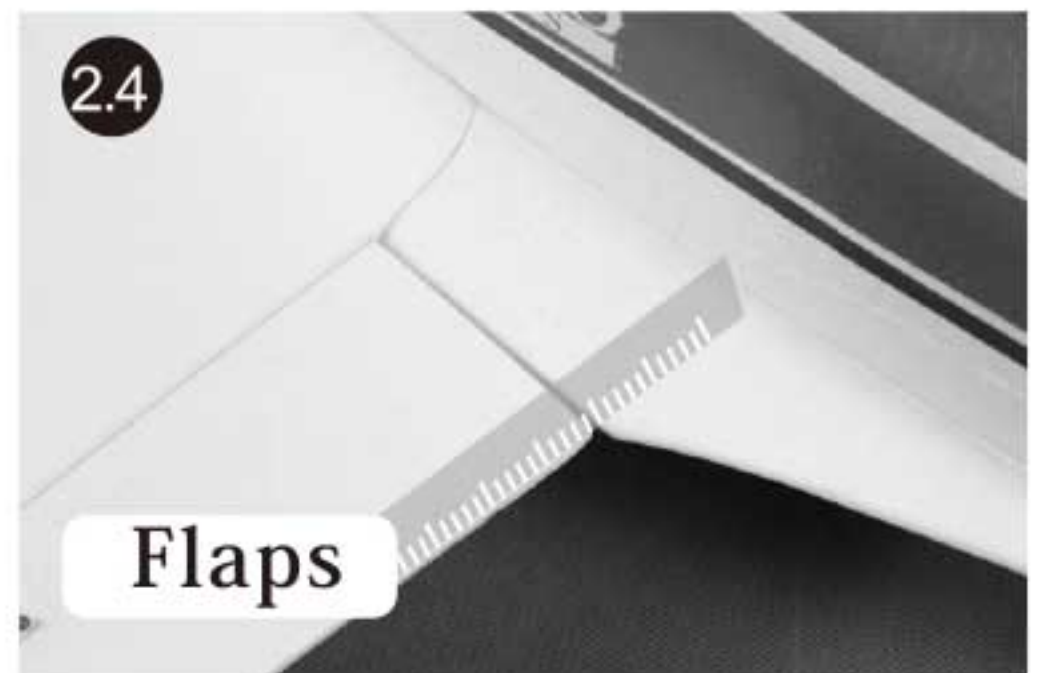
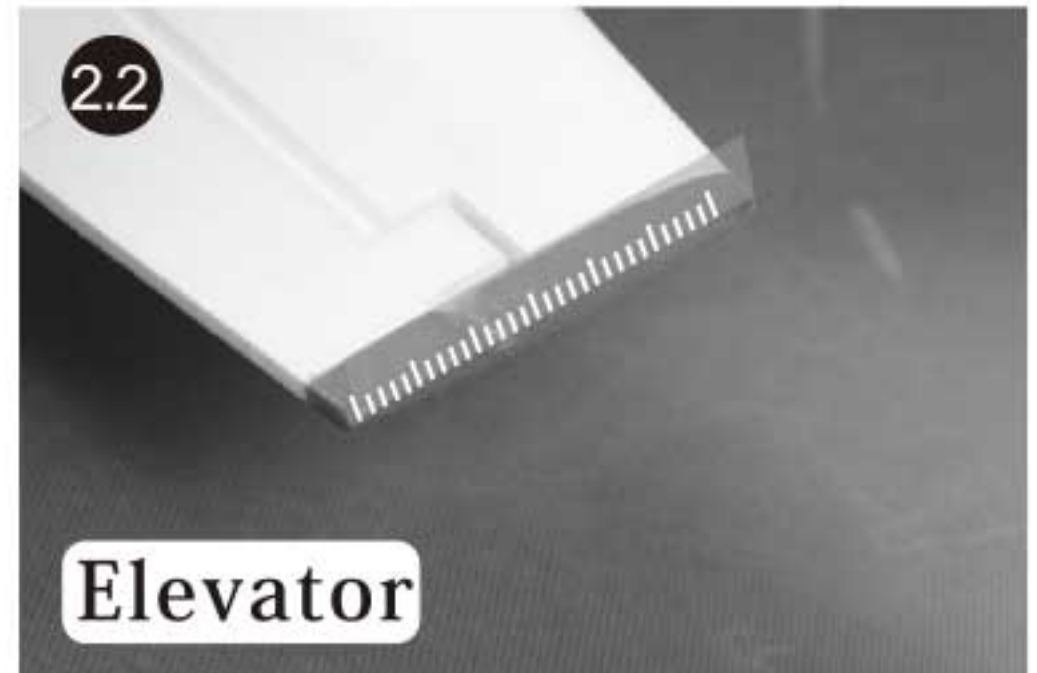

Final assembly and set-up procedures

Check the control throws

1. Adjust ATV/travel adjustment on your transmitter until you obtain the following control surface travel. Do not adjust dual rates until you have correctly adjusted the total travel.

Ailerons: 12mm up and down (both ailerons), refers to the flaps up position.

Elevator: 13mm up and down, measured at the elevator root.

Rudder: 15mm left and right, refers to the centerline of the vertical fin.

Flaps: Full 35mm

2. The dual rates and the Exponential setting for intermediate flyers of **Strega** are based on the ATV set in previous step.

	High Rate	Expo	Low Rate	Expo
Aileron	100% 12mm up/down	30%	69% 7.2mm up/down	20%
Elevator	100% 13mm up/down	25%	63% 7.8mm up/down	20%
Rudder	100% 15mm left/right	25%	75% 9mm left/right	15%

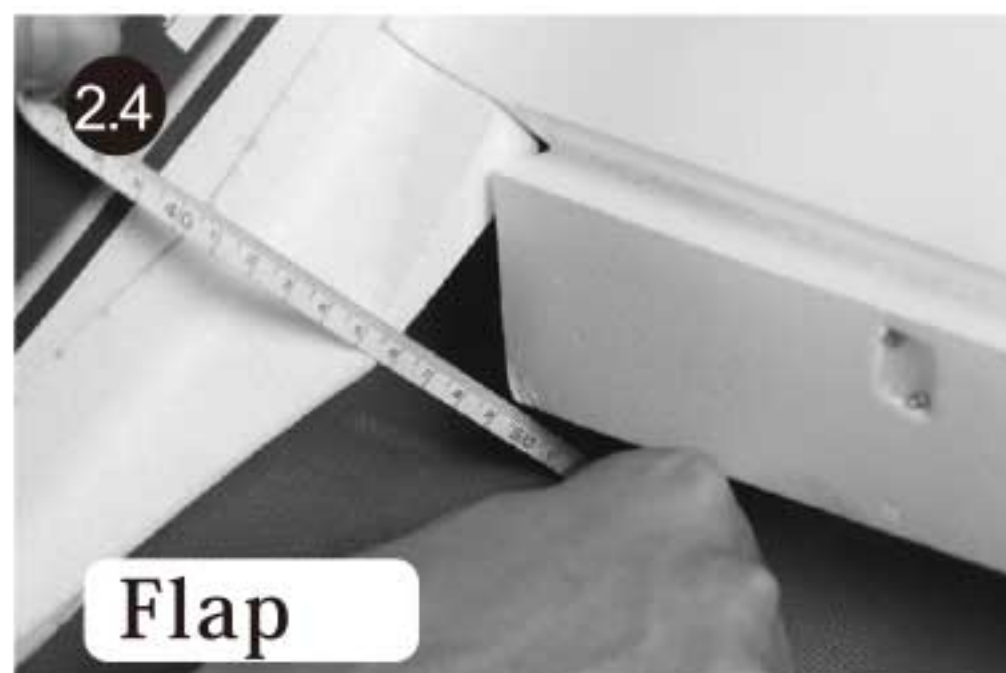

Final assembly and set-up procedures

Note: 1. This control throws were developed by R&D department for the best performance of the **strega**. The small mount of elevator throw on low rate is capable of extreme aerobatics.

2. At first flight, fly the model in low rate. The first time you use high rates, be sure to fly at low to medium speeds. High rates, as listed, are only for EXTREME maneuvering. Only switch to high rate when the plane is flying at slow speed. Never fly at high rates at full air speed. This plane is very responsive and pilot can easily lose orientation. Get familiar with the plane first and then try high rate.

3. For take off and landing, low rate in all control surfaces is strongly recommended.

Install the propeller set

Caution: Disconnect the battery from the ESC before installing the propeller. Before testing the propeller, make sure the tail of the plane is firmly on the ground and ensure there are no people or objects in the range of the propeller. Make sure the throttle is in the off position (lowest position) before plugging in the battery.

1. Install the keyed spinner backplate onto the hex nut of the motor shaft.



2. Install the propeller to the motor shaft and make sure the root of the propeller sits right on the saddle with the painted propeller tips facing the front of the plane.



3. Install the washer.



Final assembly and set-up procedures

- Secure the bullet into place using a screw driver.



- Secure the spinner into place using the included machine screw.



Install the accessories

- Glue the air speed head onto the starboard wing tip.



- Install the vortex generators. The one with the recessed slot is for the starboard wing tip.

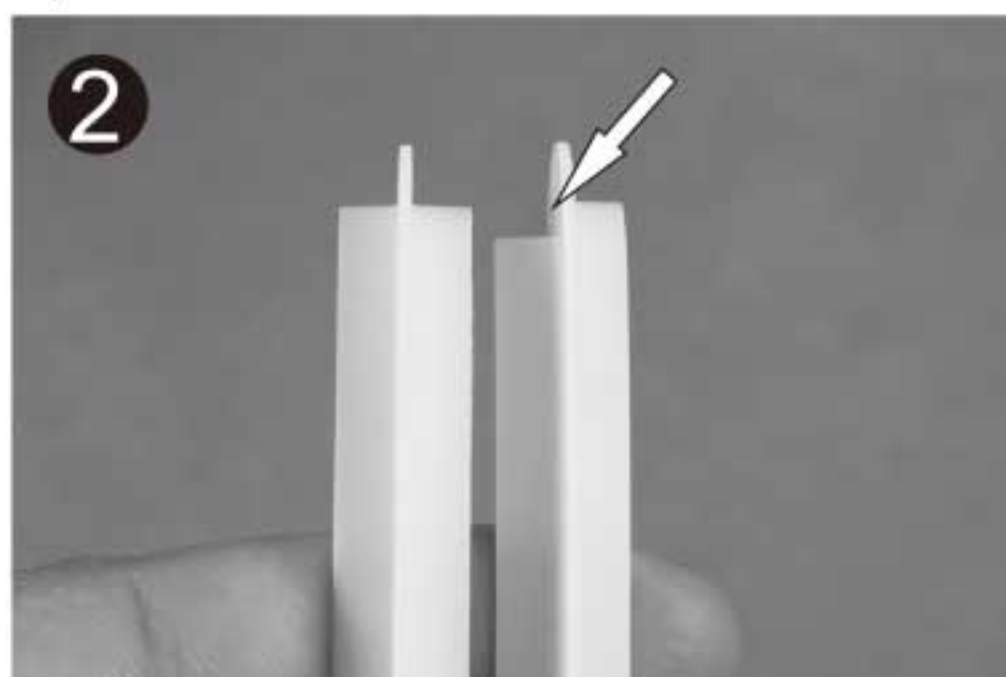

- Install the starboard vortex generator into place by dry fitting into place first.



- Glue the generator into place. Repeat steps 2 & 3 for the left vortex generator.



Final assembly and set-up procedures

Check the C.G. (Center of Gravity)

Center of Gravity

When balancing your model, adjust the motor battery as necessary so the model is level or slightly nose down. This is the correct balance point for your model. After the first flights, the **CG** position can be adjusted for your personal preference.

1. The recommended Center of Gravity (**CG**) location for your model is (**93mm/3.7in**) forward from the root of leading edge of the main wing (as shown) with the battery pack installed. Mark the location of the **CG** on top of the wing.

2. When balancing your model, support the plane at the marks made on the top of the main wing with your fingers or a commercially available balancing stand. This is the correct balance point for your model. Make sure the model is assembled and ready for flight before balancing.

3. Always balance the plane with the retracts down.

Caution: Do not connect the battery to the ESC while balancing the plane.



How to change the power combo for the different flight experience?

Roc Appendix

1. If you get the plane in the high speed racing version and want to fly at low speed, just plug and play it after the installation with the recommended battery packs.
2. If you have purchased the normal speed version racer and then you want to upgrade the speed to a high level, please refer to the following steps to change to an upgraded version.

Note: If you have upgraded the power plant to the high speed version, you should upgrade the ESC and the battery to the recommended version accordingly. If not, you may damage your ESC, battery or motor.

- 2.1.** Bolt the cross mount on head end of the motor.

Note: Apply a drop of medium thread lock on the bolt before securing the mount in place.



- 2.2.** Insert the ESC from the bottom of the battery tray to the front of the ESC hatch with the aluminum radiator facing up.



- 2.3.** Connect to the ESC, testing to make sure the motor rotates in the right direction. If the motor rotates in the wrong direction, reverse any two wires between the ESC and the motor. Make sure to slightly pinch the cable part instead of the shrink tube if using metal pliers.

Caution: Do not install the propeller set to the motor or touch the outrunner motor while testing to avoid injury.

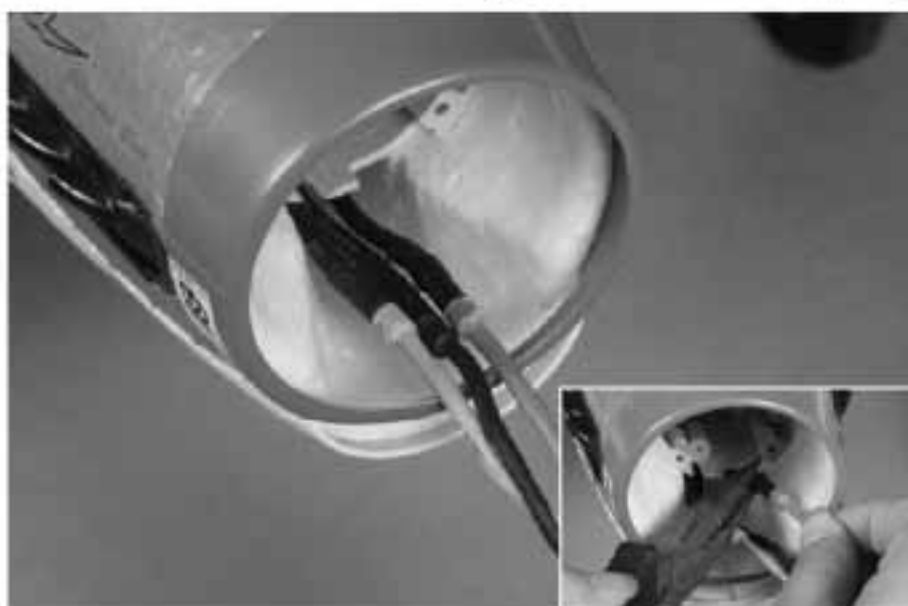

- 2.4.** Secure the motor assembly to the motor board.

Note: Make sure to secure the mount to the recessed slot on the motor base to avoid any gap between the cowl and the spinner. The previous steps can be used to change to the low speed combo, EXCEPT the low speed motor will be attached to the NON-recessed slots on the motor board.

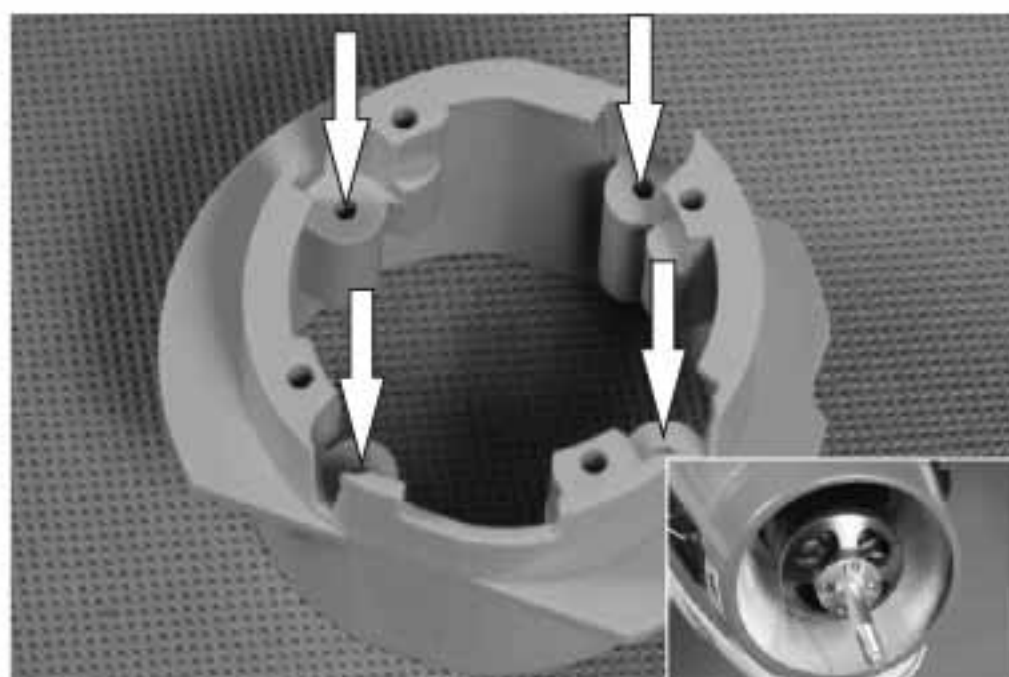

Before flying the model

Find a suitable flying site

Find a flying site clear of buildings, trees, power lines and other obstructions. Until you know how much area will be required and have mastered flying your plane in confined spaces, choose a site which is at least the size of two to three football fields – a flying field specifically for R/C planes is best. Never fly near people– especially children who can wander unpredictably.

Perform the range check of your plane

As a precaution, an operational ground range test should be performed before the first flight each time you go out. Performing a range test is a good way to detect problems that could cause loss of control such as low batteries, defective or damaged radio components, or radio interference. This usually requires an assistant and should be done at the actual flying site you will be using.

First turn on the transmitter, then install a fully-charged battery into the fuselage. Connect the battery and install the hatch.

Remember, use care not to bump the throttle stick, otherwise, the propeller / fan will turn and possibly cause damage or injury.

Note: Please refer to your **Transmitter Manual** that came with your radio control system to perform a ground range check. If the controls are not working correctly or if anything seems wrong, do not fly the model until you correct the problem. Make certain all the servo wires are securely connected to the receiver and the transmitter batteries have a good connection.

Monitor your flight time

Monitor and limit your flight time using a timer (such as one on a wrist watch or in your transmitter if available). When the batteries are getting low you will usually notice a performance drop before the ESC cuts off motor power, so when the plane starts flying slower you should land. Often (but not always) power can be briefly restored after the motor cuts off by holding the throttle stick all the way down for a few seconds.

To avoid an unexpected dead-stick landing on your first flight, set your timer to a conservative 4 minutes. When your alarm sounds you should land right away.

Flying your model

Take off

While applying power slowly steer to keep the model straight, the model should accelerate quickly. As the model gains flight speed, you will want to climb at a steady and even rate. The **Strega** will climb out at a nice angle of attack (AOA).

Flying

Always choose a wide-open space for flying your plane. It is ideal for you to fly at a sanctioned flying field. If you are not flying at an approved site, always avoid flying near houses, trees, wires and buildings. You should also be careful to avoid flying in areas where there are many people, such as busy parks, schoolyards, or soccer fields. Consult laws and ordinances before choosing a location to fly your aircraft. After takeoff, gain some altitude. Climb to a safe altitude and begin to trim the model till it's tracks well through all aspects of flight, including high speed passes, inverted flight, loops, and point rolls.

Landing

Land the model when you hear the motor pulsing (LVC) or if you notice a reduction in power. If using a transmitter with a timer, set the timer so you have enough flight time to make several landing approaches.

Recharge the battery and repair the model as needed. The model's three point landing gear allows the model to land on hard surfaces. Align model directly into the wind and fly down to the ground. Fly the airplane down to the ground using 1/4-1/3 throttle to keep enough energy for proper flare. Before the model touches down, always fully decrease the throttle to avoid damaging the propeller or other components. The key to a great landing is to manage the power and elevator all the way to the ground and set down lightly on the main landing gear. After a few flights you will find the model can be set down lightly on the mains and you can hold the tail wheel off balancing the model on the mains till it slows and gently settles the tail.

Maintenance

Repairs to the foam should be made with foam safe adhesives such as hot glue, foam safe CA, and 5 min epoxy. When parts are not repairable, see the Spare Parts List for ordering by item number.

Always check to make sure all screws on the aircraft are tightened. Pay special attention to make sure the bullet of the rotor adaptor is firmly in place before every flight.

Troubleshooting

Problem	Possible Cause	Solution
Aircraft will not respond to the throttle but responds to other controls.	<ul style="list-style-type: none"> - ESC is not armed. - Throttle channel is reversed. 	<ul style="list-style-type: none"> - Lower throttle stick and throttle trim to lowest settings. - Reverse throttle channel on transmitter.
Extra propeller noise or extra Vibration.	<ul style="list-style-type: none"> - Damaged spinner, propeller, motor, or motor mount. - Loose propeller and spinner parts. - Propellor installed backwards. 	<ul style="list-style-type: none"> - Replace damaged parts. - Tighten parts for propeller adapter, propeller and spinner.
Reduced flight time or aircraft underpowered.	<ul style="list-style-type: none"> - Flight battery charge is low. - Propeller installed backward. - Flight battery damaged. 	<ul style="list-style-type: none"> - Remove and install propeller correctly. - Completely recharge flight battery. - Replace flight battery and obey flight battery instructions.
Control surface does not move, or is slow to respond to control inputs.	<ul style="list-style-type: none"> - Control surface, control horn, linkage or servo damage. - Wire damaged or connections loose. 	<ul style="list-style-type: none"> - Replace or repair damaged parts and adjust controls. - Do a check of connections for loose wiring.
Controls reversed.	Channels are reversed in the transmitter.	Do the Control Direction Test and adjust controls for aircraft and transmitter.
<ul style="list-style-type: none"> - Motor loses power. - Motor power pulses then motor loses power. 	<ul style="list-style-type: none"> - Damage to motor, or battery. - Loss of power to aircraft. - ESC uses default soft Low Voltage Cutoff(LVC). 	<ul style="list-style-type: none"> - Do a check of batteries, transmitter, receiver, ESC, motor and wiring for damage (replace as needed). - Land aircraft immediately and Recharge flight battery.
LED on receiver flashes slowly.	Power loss to receiver.	<ul style="list-style-type: none"> - Check connection from ESC to receiver. - Check servos for damage. - Check linkages for binding.

AMA

If you are not already a member of the AMA, please join, The AMA is the governing body of model aviation and membership provided liability insurance coverage, protects modelers' rights and interests and is required to fly at most R/C sites.

Academy of Model Aeronautics

5151 East Memorial Drive

Muncie, IN 47302-9252

Ph.(800)435-9262

Fax(765)741-0057

Or via the Internet at: <http://www.modelaircraft.org>



Academy of Model Aeronautics National Model Aircraft Safety Code Effective January 1, 2011

- A. GENERAL:** A model aircraft is a non-human-carrying aircraft capable of sustained flight in the atmosphere. It may not exceed limitations of this code and is intended exclusively for sport, recreation and/or competition.
All model flights must be conducted in accordance with this safety code and any additional rules specific to the flying site.
1. Model aircraft will not be flown:
 - (a) In a careless or reckless manner.
 - (b) At a location where model aircraft activities are prohibited.
 2. Model aircraft pilots will:
 - (a) Yield the right of way to all man carrying aircraft.
 - (b) See and avoid all aircraft and a spotter must be used when appropriate.
(AMA Document #540-D-See and Avoid Guidance.)
 - (c) Not fly higher than approximately 400 feet above ground level within three (3) miles of an airport, without notifying the airport operator.
 - (d) Not interfere with operations and traffic patterns at any airport, heliport or seaplane base except where there is a mixed use agreement.
 - (e) Ensure the aircraft is identified with the name and address or AMA number of the owner on the inside or affixed to the outside of the model aircraft.
(This does not apply to model aircraft flown indoors).
 - (f) Not operate aircraft with metal-blade propellers or with gaseous boosts except for helicopters operated under the provisions of AMA Document #555.
 - (g) Not operate model aircraft while under the influence of alcohol or while using any drug which could adversely affect the pilot's ability to safely control the model.
 - (h) Not operate model aircraft carrying pyrotechnic devices which explode or burn, or any device which propels a projectile or drops any object that creates a hazard to persons or property.

Exceptions:

- ◆ Free Flight fuses or devices that burn producing smoke and are securely attached to the model aircraft during flight.
 - ◆ Officially designated AMA Air Show Teams (AST) are authorized to use devices and practices as defined within the Team AMA Program Document (AMA Document #718).
3. Model aircraft will not be flown in AMA sanctioned events, air shows or model demonstrations unless:
 - (a) The aircraft, control system and pilot skills have successfully demonstrated all maneuvers intended or anticipated prior to the specific event.
 - (b) An inexperienced pilot is assisted by an experienced pilot.
 4. When and where required by rule, helmets must be properly worn and fastened. They must be OSHA, DOT, ANSI, SNELL or NOCSAE approved or comply with comparable standards.

B. RADIO CONTROL (RC)

1. All pilots shall avoid flying directly over unprotected people, vessels, vehicles or structures and shall avoid endangerment of life and property of others.
2. A successful radio equipment ground-range check in accordance with manufacturer's recommendations will be completed before the first flight of a new or repaired model aircraft.
3. RC model aircraft must use the radio-control frequencies currently allowed by the Federal Communications Commission (FCC). Only individuals properly licensed by the FCC are authorized to operate equipment on Amateur Band frequencies.
4. RC model aircraft will not operate within three (3) miles of any pre-existing flying site without a frequency-management agreement (AMA Documents #922-Testing for RF Interference; #923- Frequency Management Agreement)
5. With the exception of events flown under official AMA Competition Regulations, excluding takeoff and landing, no powered model may be flown outdoors closer than 25 feet to any individual, except for the pilot and the pilot's helper(s) located at the flight line.
6. Under no circumstances may a pilot or other person touch a model aircraft in flight while it is still under power, except to divert it from striking an individual. This does not apply to model aircraft flown indoors.
7. RC night flying requires a lighting system providing the pilot with a clear view of the model's attitude and orientation at all times.
8. The pilot of a RC model aircraft shall:
 - (a) Maintain control during the entire flight, maintaining visual contact without enhancement other than by corrective lenses prescribed for the pilot.
 - (b) Fly using the assistance of a camera or First-Person View (FPV) only in accordance with the procedures outlined in AMA Document #550.

C. FREE FLIGHT

1. Must be at least 100 feet downwind of spectators and automobile parking when the model aircraft is launched.
2. Launch area must be clear of all individuals except mechanics, officials, and other fliers.
3. An effective device will be used to extinguish any fuse on the model aircraft after the fuse has completed its function.



**Email: info@fmsmodel.com
[Http://www.rochobby.com](http://www.rochobby.com)**

MADE IN CHINA